

IS2500: RFID Systems 2022

Mark T. Smith
KTH: Swedish Royal Institute of Technology
School of EECS
msmith@kth.se

Course Goals

- The ultimate goal is an understanding of RFID technologies ranging from how they work from a radio point of view to how they solve application problems.
- Radio concepts that apply to RFID, RFID devices, systems and other technology needed to realize RFID in IT products or complex systems.
- Start with radio concepts, and move towards system solutions.
- Actually implement this stuff! Hands-on. Make things that work.
- In addition to technologies and applications, we will discuss personal, social, political and other aspects of RFID deployment and usage.
- You should be able to exercise these skills as an independent scientist, employee, entrepreneur or consultant.

Course Logistics

- Lecture days, times and location: Be sure to check Schema!
- Project day, time: See Schema for times! Always in the Mentorspace.
- Readings and assignments.
- Project presentation and demo.
- Final written project report.

Textbook: *The RF in RFID* by Daniel M. Dobkin

Start by reading Chapters 1 and 2 in the textbook

Next week will be the first homework assignment

The course outline and all details are on the course web page

<http://people.kth.se/~msmith>

RFID Market

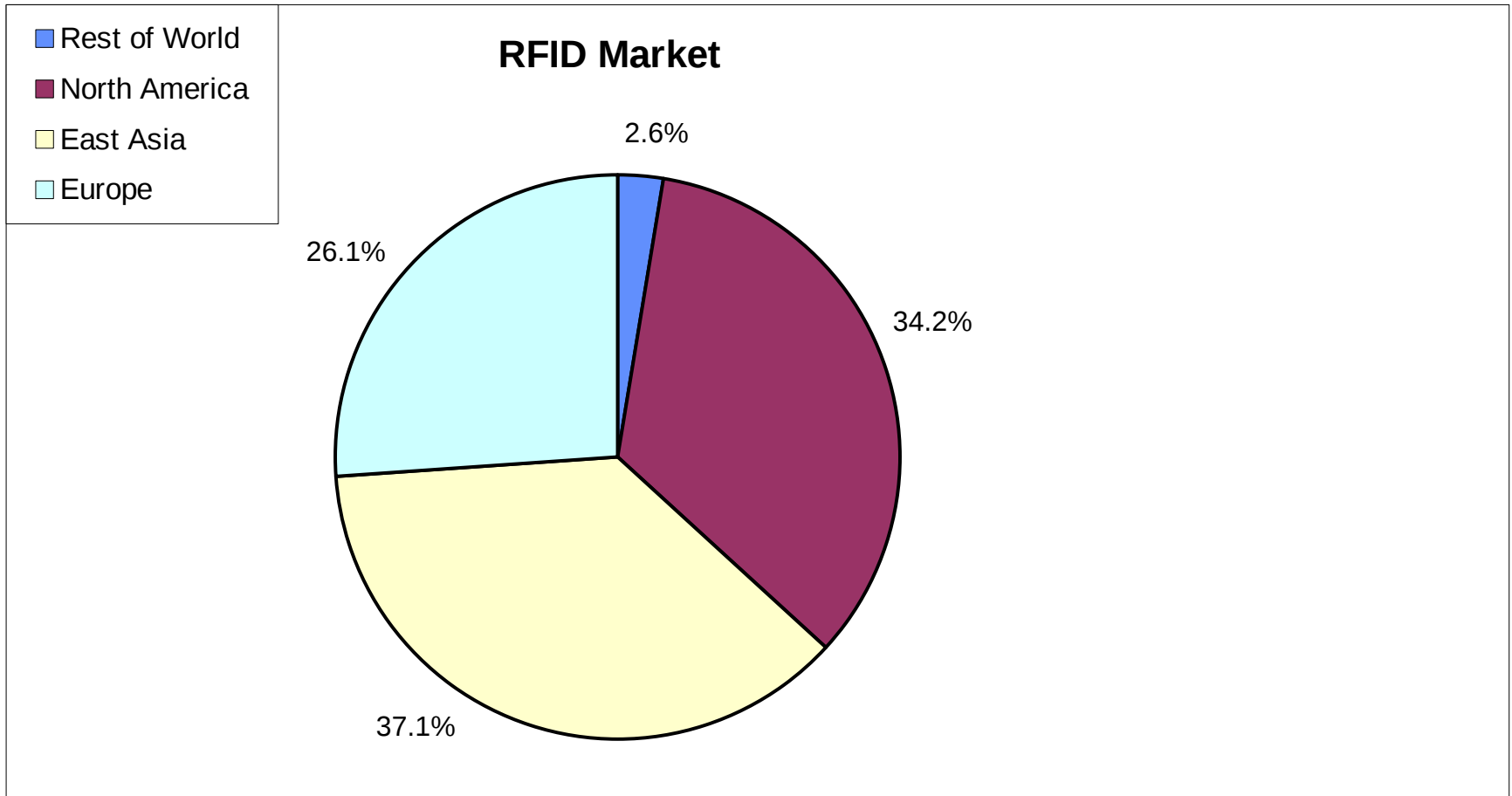

The value of the worldwide RFID market was > 7 Billion €.

The market is projected to grow on average 15-17% per year through 2016.

Source of data: IDTechEx 2012

RFID is:

- A way to label or 'tag' with data people, places and things for a variety of uses. Here are a few examples:
- Identity management. A way to identify people by use of a token.
- Data exchange. *Anything* can store and exchange data now.
- Object logistics! This is a significant business area.
 - Store inventory tracking (IKEA or Book Stores for example)
 - Supply chain management for manufacturing
 - Asset tracking. "Where is the expensive equipment?"
- Labeling things in a wireless, machine readable form.
 - Product information such as ingredients or energy content
 - Prices and payments (We will discuss payment and NFC)
 - Manufacturing information, such as dates or 'lot numbers'
 - Product history, such as who paid for something and when

Example: RFID tags for “animals”

(Bio-hackers seem to like these too.)

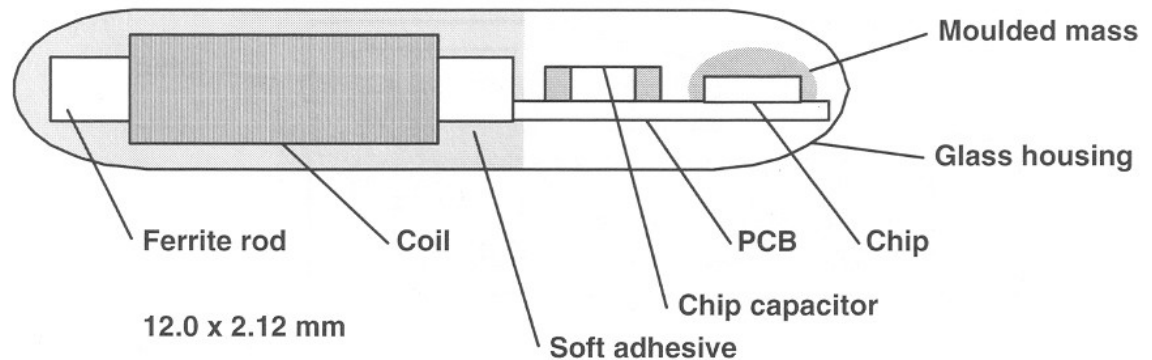
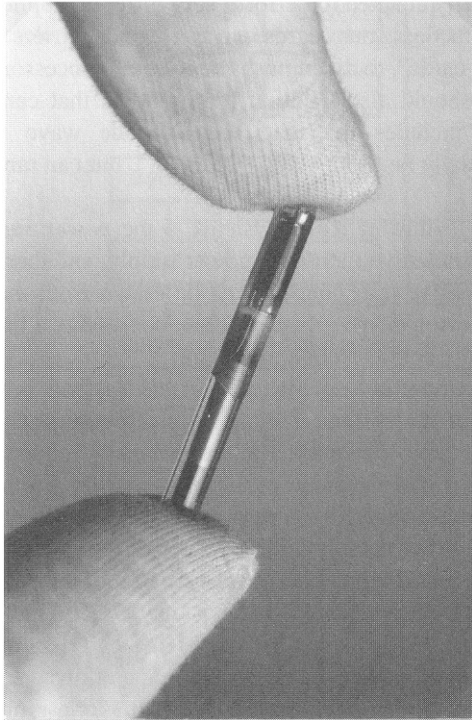

These are short range, inductively coupled tags. $f_c = 125$ Khz.
Can you explain why the very low carrier frequency?

Other big picture RFID attributes

- Information about people, places and things is available to be read wirelessly (thus the RF in RFID). It is 'non-contact' reading.
- It uses radio technology. There are standards and regulations.
- There are several different kinds of RFID, each with attributes that make it preferred for specific applications.
- RFID transactions follow an 'interrogation' scheme. A reader interrogates, and a tag replies. Readers initiate transactions, not tags.
- The RFID components rarely form a solution in themselves. You use them to make a larger IT product or system.

Typical RFID system solution architecture

Figure 2.9 in the book diagrams typical RFID application systems. Note the potential for data services. We could add that here.

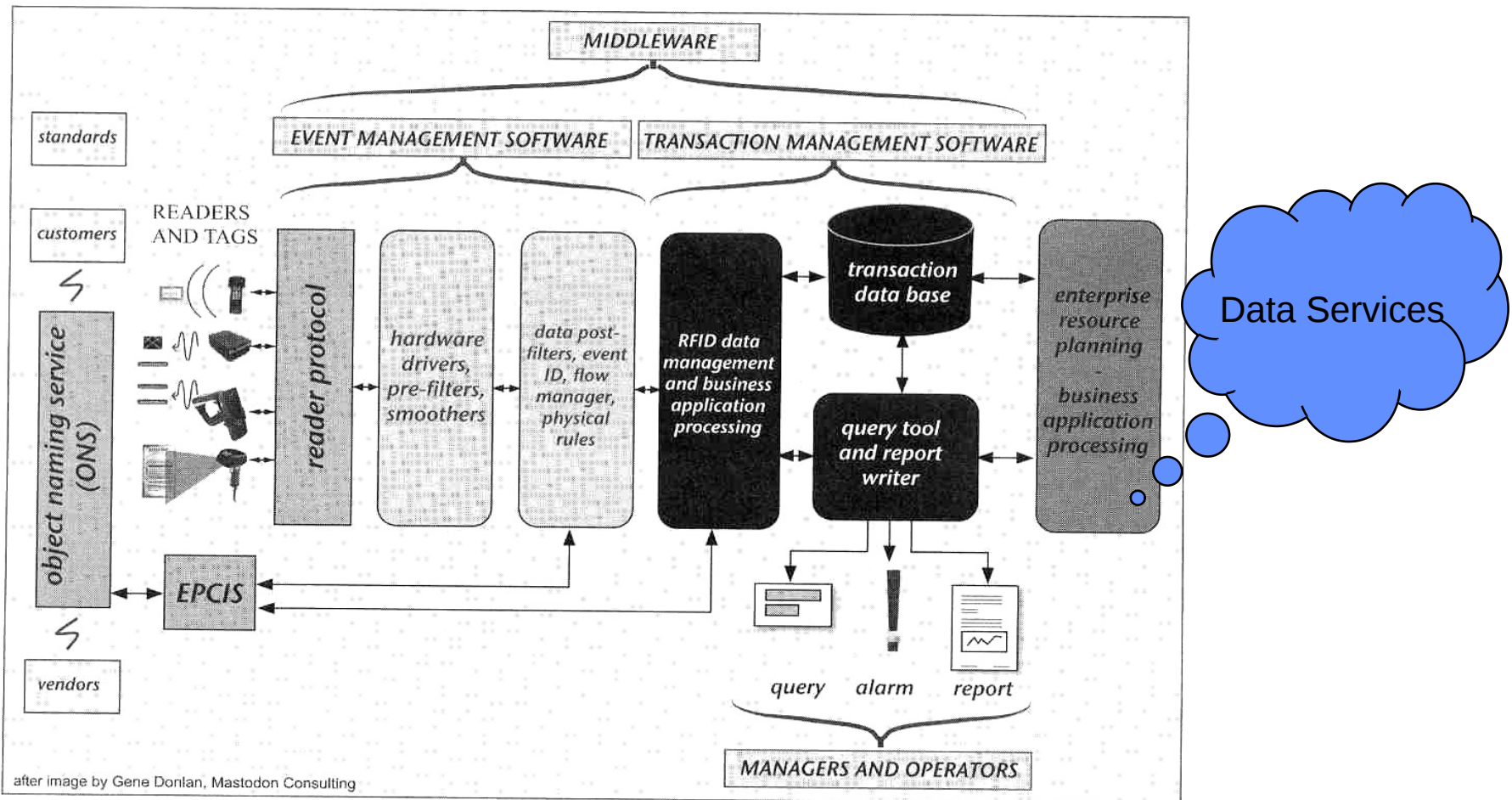

Figure 2.9: RFID as a Sensor Within an Overall Software Infrastructure.

The example gives key fundamentals of RFID

- The airplane doesn't radiate any radio energy. It simply reflects electro-magnetic (EM) energy that the radar transmitter sent.
 - Except for one type of RFID, all RFID systems do this in some way.
 - The RFID technology we will study does this.
- The radar station on the ground both transmits out EM energy and receives what comes back. It initiates the exchange of information.
- RFID systems have exact equivalents. There is a *reader* that initiates exchange of information. Sometimes the reader is called an interrogator.
- RFID systems also have the part that reflects the EM energy. It is usually called the *tag*. Sometimes tags are called transponders.

More key fundamentals of RFID

- By rolling, the airplane changes how much energy it reflects (radar cross section). By doing this, it adds information to the radio energy.
 - All RFID systems add information by modulating the reflected energy.
 - It does it by modulating either the amplitude or phase of the signal.
- The airplane provided its own power to perform the modulation, in this case engine power was used to roll the airplane.
 - Some RFID tags do provide their own power to perform modulation, usually by having a battery.
 - These are called “semi-passive” tags.
 - Most tags take power from the sent radio energy. They provide no power sources of their own. Energy harvesting!
 - These are called “passive” tags.

Quick taxonomy of RFID systems

- Backscattering systems use tags that reflect EM energy sent from a reader.
- Active transponders use tags that have their own transmitters in them. They don't backscatter anything. They transmit their own radio signal in reply to a request from an interrogator.
- Passive tags get all their operating power from the EM energy sent by the reader.
- Semi-passive tags get their operating power from a battery. They usually have a longer read distance than passive tags.
- Inductive systems use near-field coupled EM energy exchange. Range of a few centimeters.
- Radiative systems use radio wave propagation to perform EM energy exchange. Passive radiative tags can have ranges of a few meters. Semi-passive radiative tags can have ranges of tens of meters. Active transponders can have ranges of kilometers.
- All of these systems follow the physics of radio.

Summary of RFID taxonomy

See Figure 2.16 in the textbook.

Some familiar RFID

RFID is all around us in everyday life. Here are some familiar applications.



RFID anti-theft tags used in retail stores. They only send out 1 bit of information (whether or not the item having the tag was paid for).

RFID used for subway payment verification



The blue and white areas on the entry gates are RFID readers.

They have advantages over the old magnetic stripe card.

Especially from a user interface and reliability viewpoint.

Note that this just *verifies* that you have already paid!

Real mobile payment is coming with Near Field Communication (NFC) NFC is RFID.

ID management for building entry



- These are very common,
- There are many standards.
- They are inductively coupled.
- No battery, fully passive.

- Current systems are very simple and easy to defeat.
- NFC will be a major market here are well.

Active Transponders



These are shown in the book. They are typical transponders used to pay road fees.

They are not cheap, but they save money through automation.

Simple RFID and a bit of radio

Although it is simple, it is probably the most used form of RFID today!

Simple RFID uses resonance circuit phenomena as is often used in radio. Here is a simple way to see how it can work. Take an inductor (coil of wire) and a capacitor and form a parallel LC circuit:

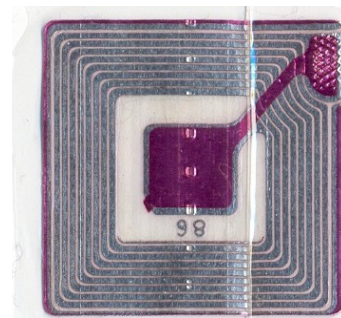
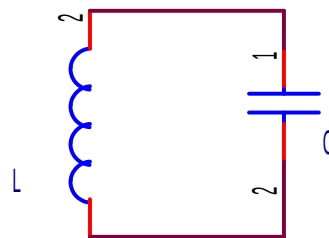
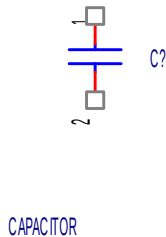
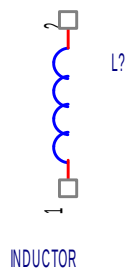

Now, inductively couple AC energy into this using a signal source like a signal generator. Look at the energy induced into the parallel LC circuit as a function of the voltage across it.

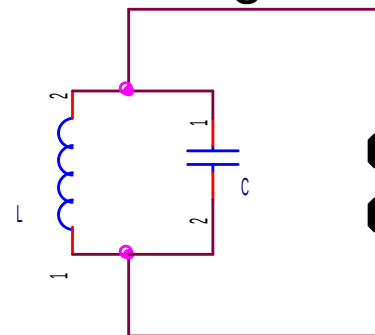
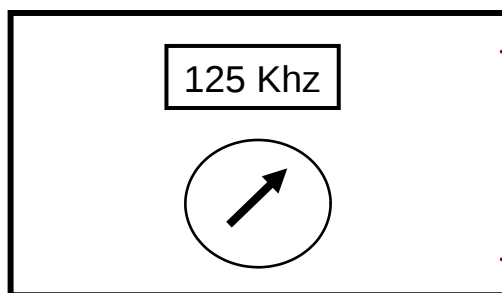

Voltage to look at

Build a table of ID vs resonant frequency

Change the frequency until you find where 'I' is greatest.

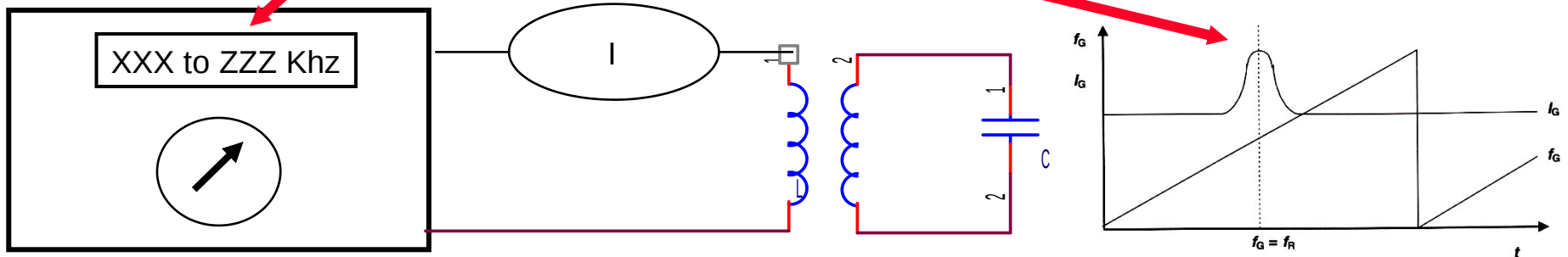

- Instead of V_{max} , look at energy transfer from the signal generator.
- For every ID token, build a unique LC circuit.
- Build a table of resonant frequency vs ID.
- As the user presents their token to the signal generator, sweep the generator over a present frequency range.
- Looks for energy transfer peaks.
- Look up the ID in the table.

Use multiple LC circuits for large numbers of tokens or a small frequency range

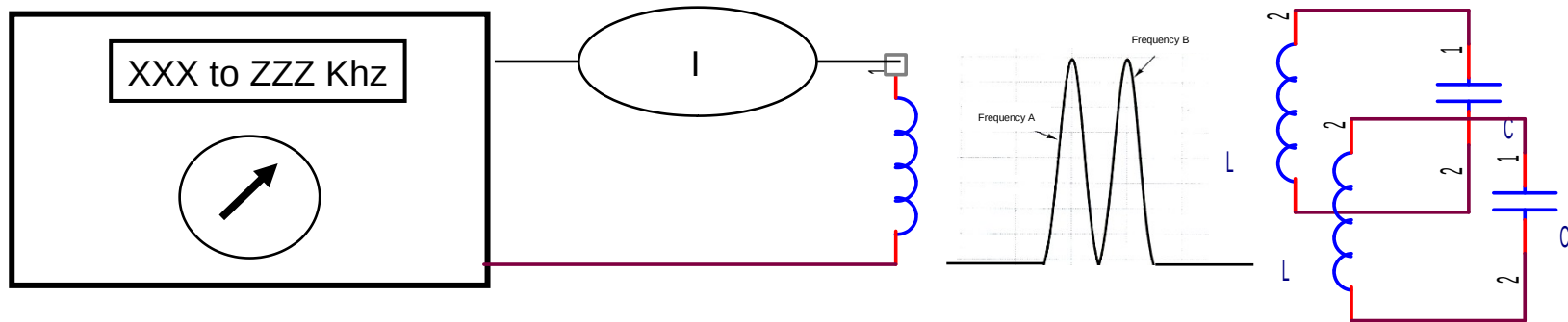

If you have more tokens than resolvable frequencies, use multiple LC circuits per token. Users are identified by a series of peaks.

Factors that influence choice of what RFID type to use

They tend to fall into performance, power and cost. Here are examples.

Performance:

- Bandwidth. How much data needs to be sent, and how fast.
- Range. How far away does the tag need to be and still be read.
- Flexibility. Is ID all the application needs? What about other parameters such as location, media content, or data encryption?
- Addressing. How many tags can appear to the reader at once and how fast can a reader detect them.
- Reliability. How many chances are there to read the tag correctly? What are the consequences if it can't be read?
- Standards. Should the format be proprietary, or should it follow a widely adopted standard like EPC.
- Price. How expensive are the readers? How expensive are the tags???

More factors

Power

- What is the least amount of reader power necessary to get the performance required?
- What part of the RF spectrum is being used?
- Are there any government regulations that apply, for example maximum allowed power?

Cost of use. This is different from the tag and reader direct cost

- What is the cost of the tag compared to the cost of what is being tagged?
- Can the tag be reused, or is it to be thrown away?
- How long does the tag need to last?
- What about sustainability? Will you have to recycle the tags? What about the batteries if any are used?

Try this for the bookstore tag

- Bandwidth. How much data needs to be sent, and how fast.
 - One bit that indicates if you have paid for the book.
- Range. How far away does the tag need to be and still be read.
 - Less than 0.5 meter. The tag is scanned when you leave the shop.
- Flexibility. Is ID all the application needs?
 - One bit is enough. The store just wants to know that you paid.
- Addressing. How many tags can appear to the reader at once.
 - As many tags as the customer has books. They can all be the same.
- Reliability. How many chances are there to read the tag correctly?
 - Only one chance. But, it is more of a theft prevention than detection.
- Standards. Should the format be proprietary?
 - Definitely not. All anti theft tags should be identical and cheap.
- Price. How expensive are the readers? How expensive are the tags???
 - Both are cheap. The tags are very, very cheap. Less than 1 euro cent.

The Connection between Radio and RFID

- To understand the connections between the RFID and what determines the RFID system characteristics that an application needs, we have to dig into the physics of radio.
- We will develop it as we go. Basic radio isn't very hard stuff.
- The first thing we will develop is the relationship of frequency and wavelength.
- This has a direct impact on our choice of frequency "band" the system will use. This also determines whether we are inductively or radiatively coupled.

A model of radio

What is a radio? At least in a functional sense.

(From an application point of view, what a radio is depends on your age.)

- A radio is a device that allows the transmission and/or reception of electromagnetic energy.
- Physics describes the limits, for example how fast the energy can travel and how much information it can transfer with it.
- Realize that radio as we know it is only about 100 years old.
- It is still evolving. For example the recent migration from analog television to digital television. (A television is just a radio that can send pictures as information content.)

Time and adoption of radio and TV

Especially note how long it takes for a new technology to become widely used.

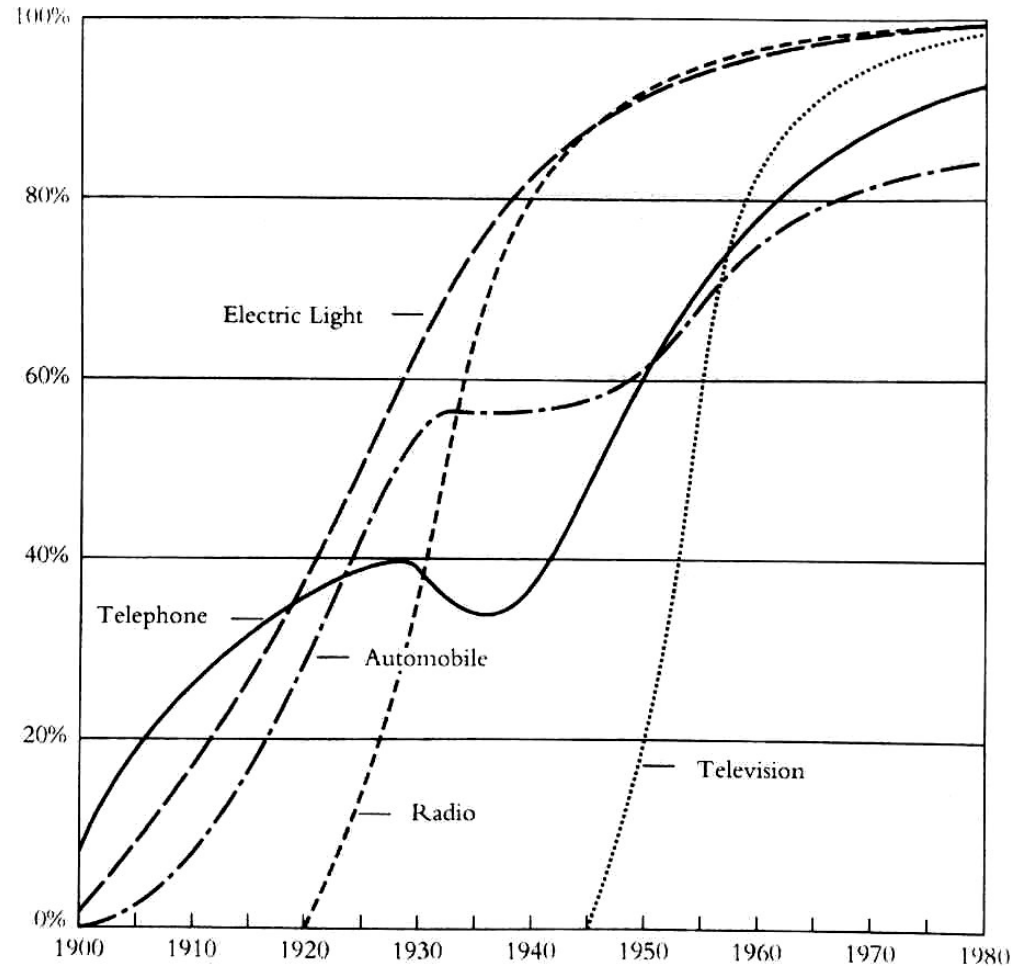

Radio doesn't have to be complicated

This is a radio receiver. It's a "crystal" radio. Six parts in all.
Total cost < 1 Euro (w/o the headphone).

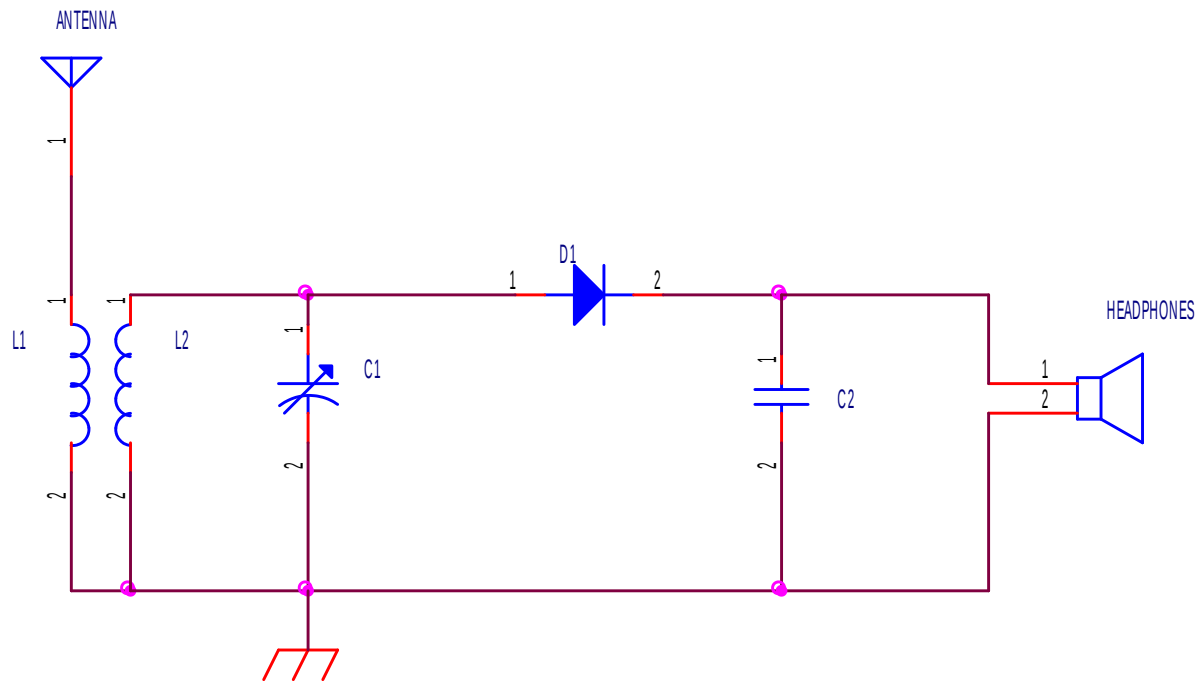

Review of frequency and wavelength

- Electromagnetic energy can vary in amplitude and frequency.
- For radio, frequency is typically from a few khz to many ghz.
- Some examples:
 - AC power out of the wall varies at 50 hz in most countries
 - AM broadcast radio extends from about 500 khz to 1.6 mhz
 - FM broadcast radio extends from about 88 mhz to 108 mhz
 - Cell phones operate near 800 mhz, 900 mhz , 1.8 ghz and 1.9 ghz
 - GPS receivers operate at about 1.3 ghz
 - 802.11b and g WiFi operates at about 2.4 ghz
- Wavelength is related to frequency by the speed of light.

$$\text{wavelength} = \lambda = c / f$$

- The amount of time it takes to go through 1 cycle is just $1/f$.
- The lower the frequency, the longer the wavelength.

The frequency of EM energy has an impact on how the energy interacts with matter

For example, how well does radio energy propagate through things? One measure is to use *skin depth*:

$$\text{skin depth} \approx \sqrt{\frac{1}{\pi \mu_0 \sigma f}}$$

μ_0 is magnetic permeability
 σ is electrical conductivity

RF goes through air easily. Water, not so well. Metal blocks it.

Material	125 khz	13.5 mhz	900 mhz	2.4 ghz
Fresh Water	8 m	2 m	4 cm	8 mm
Humans	2 m	60 cm	2 cm	8 mm
Aluminum	0.23 mm	71 um	2.7 um	1.6 um
Copper	0.18 mm	55 um	2.1 um	1.3 um

If you were in a submarine 10 m deep in the ocean and needed to contact someone in the EU by radio, could you do it?

As we will see later, frequency has a big impact on antenna design and size

A common antenna found in wireless networking cards and radiative RFID tags is a “half wavelength dipole”. As the name suggests, it is $\lambda / 2$ long.

Frequency	2.4 ghz	900 mhz	13.5 mhz	125 khz	30 khz
$\lambda / 2$	6.25 cm	16.6 cm	11.11 m	1.2 km	5 km

What about that submarine? Fortunately, the ocean is big.

RFID tags aren't very big, so the coupling (inductive or radiative) you choose is very frequency dependent.

Frequency vs coupling model

Frequency dictates what kind of coupling model the system will use.

See Figure 2.10 in the textbook.

Inductive vs Radiative

See Figure 2.11 in the textbook.

Inductive tags will have antennas that are in effect coils.
Radiative tags will have antennas that are in effect wires or patches.

See Figure 2.14 in the textbook.